

Direct Drive Belt Winch

Australian Made Poultry Winches for Drinker and Ventilation Applications

W400B3+C

Poultry Winches / Feeder / Drinker Winches / Direct Drive Belt Winch

Grifco's innovative Direct Drive Belt Winches have been specifically designed for the electric lifting of drinker lines in typical poultry sheds. Our winch range is Australian made and independently tested to comply with the stringent requirements of relevant Australian Standards. They are supported by a 5 year warranty and Grifco's national poultry specialist team.

Key Features

- Designed and tested to perform in corrosive environments
- Meets all applicable regulatory standards. Grifco performs thorough testing to ensure products are safe and compliant
- The high quality motor and gear box are fitted to a strong, versatile belt
- Manual override to allow operation in the absence of power
- Built in mechanical limits for perfect positioning every time

What's in the Box?

Direct Drive Belt Winch with Individual Wall Control



Product may differ slightly from image shown.

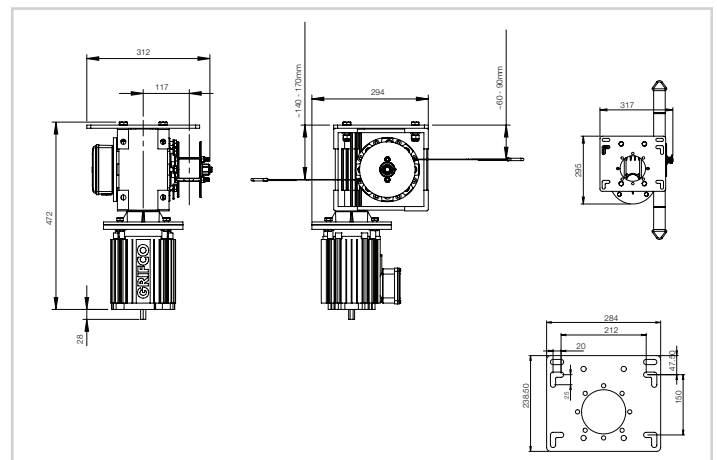

Product may differ slightly from image shown.

Model Details

Part No.	W400B3+C
Description	Poultry Belt Winch 400kg 1.0Hp 415V 3PH IP55 RG3747P

Specifications

kW	0.75kW	Phase	3ph
Amps	2.3A	Lifting Capacity	400kg
Hp	1.0Hp	IP Rating	IP55
Voltage	415V	Travel	3.8m

Mounting Plate (optional)

Part No.	Description
WMLMPF	Mounting Plate for Direct Drive Cable Winch



Multi-Station Control Cabinet (optional)

Part No.	Description
MSPC8	Control Cabinet for 8 Winches
MSPC10	Control Cabinet for 10 Winches
MSPC12	Control Cabinet for 12 Winches



Chamberlain Australia Pty Ltd

Head Office - Unit 1, 75 Epping Rd North Ryde NSW 2113
 Manufacturing - 15 Dell Rd, West Gosford NSW 2250

Chamberlain New Zealand Ltd

17A Arrenway Dr, Rosedale 0632 Auckland NZ

AU: 1800 GRIFCO | www.grifco.com.au
 NZ: 0800 653 667 | www.grifco.co.nz

Chamberlain Branches

Sydney - Unit 1, 75 Epping Rd North Ryde NSW 2113
 Melbourne - Unit 18, 85-91 Keilor Park Dr Tullamarine VIC 3043
 Brisbane - Unit 19, 140 Wecker Rd Mansfield QLD 4122
 Perth - 54 Milrose Dr Malaga WA 6090