

## Fire Shutter Operator

Operators for Fire-Rated Spring-Balanced Roller Shutters

## 58015F (L/R)

Grifco's unique portfolio of Fire Shutter Operators are designed and tested to perform on spring-balanced fire-rated roller shutters. The innovative controlled-descent mechanism ensures a safe and reliable descent in the event of an emergency.

### Key Features

- Mechanical controlled-descent mechanism
- Powerful 1.0Hp motor with purpose designed gearbox for durable, reliable operation
- Automatic chain-engage mechanism for safe and easy manual operation in the absence of power
- Choice of controls from Reversing Starters to the eDrive +2.0 Logic System for Mechanical Operators (GLMe2 portfolio)
- Rated for high duty cycle (30% run time)

### What's in the Box?

Fire Shutter Operator with Flag Mounting Bracket Only. All wall controls available separately

### Information for Roller Shutters

All operators have a recommended maximum Roller Shutter area listed in the specification table. All recommended sizes are based on a "Standard Roller Shutter" (refer below):

- The Shutter is correctly spring balanced
- The Shutter has max 1.0mm x min 100mm slats, with a Diameter 150mm drum for shutters max 36m<sup>2</sup>, or Diameter 200mm drum for shutters 36 - 50m<sup>2</sup>
- The Shutter has no wind-locks
- A sprocket ratio  $\geq 4:1$  is used

Commercial Door Operators / Fire Shutter Operators / Fire Shutter Operator



Product may differ slightly from image shown.

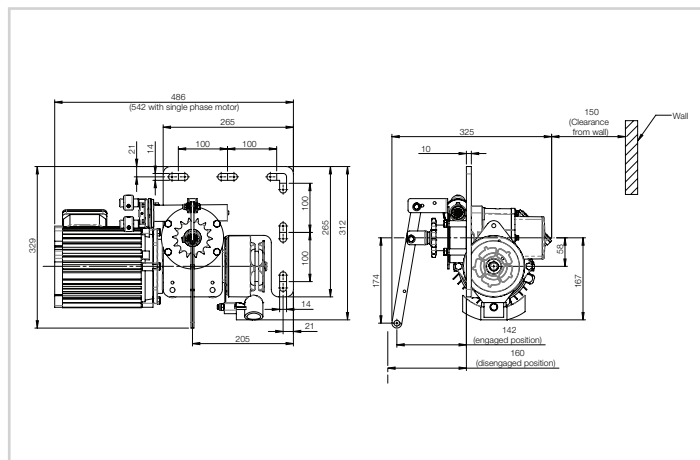

Product may differ slightly from image shown.

### Model Details

Part No.	58015F (L/R)
Description	FSO H/C 1.0Hp 415V 3PH IP44

(L/R) indicates which side of the door opening the motor is mounted to (when viewed from inside the building). For example a model with an "L" suffix is mounted to the top left of the door opening.

### Optional Controller Upgrade

Part No.	GLMe2
Description	eDrive +2.0 Logic Upgrade with Key Switch

Controller upgrade separately available. Please refer to the relevant Specification Sheet for details.

### Specifications

kW	0.75kW	Phase	3ph	No Neutral (N)	N/A
Amps	1.95A	Max SB Door Size	28m <sup>2</sup>	Pre-Wired (P)	N/A
Hp	1.0Hp	IP Rating	IP44	IP55 (W)	N/A
Voltage	415V	Duty Cycle	HC	Clutch (C)	N/A

LC = Low cycle (10% run time / hour).  
 HC = High cycle (30% run time / hour).  
 When specifying an upgraded model, please use the appropriate abbreviation before the "L" or "R" handing.  
 For example 58105FWR.

### Upgrades

No Neutral (N)	N/A
Pre-Wired (P)	N/A
IP55 (W)	N/A
Clutch (C)	N/A

Upgrades:  
 O = Optional  
 S = Supplied as standard  
 N/A = Not applicable

### Chamberlain Australia Pty Ltd

Head Office - Unit 1, 75 Epping Rd North Ryde NSW 2113  
 Manufacturing - 15 Dell Rd, West Gosford NSW 2250

### Chamberlain New Zealand Ltd

17A Arrenway Dr, Rosedale 0632 Auckland NZ

AU: 1800 GRIFCO | [www.grifco.com.au](http://www.grifco.com.au)  
 NZ: 0800 653 667 | [www.grifco.co.nz](http://www.grifco.co.nz)

### Chamberlain Branches

Sydney - Unit 1, 75 Epping Rd North Ryde NSW 2113  
 Melbourne - Unit 18, 85-91 Keilor Park Dr Tullamarine VIC 3043  
 Brisbane - Unit 19, 140 Wecker Rd Mansfield QLD 4122  
 Perth - 54 Milrose Dr Malaga WA 6090