

Fire Shutter Operator

Operators for Fire-Rated Spring-Balanced Roller Shutters

58017FF (L/R)

Commercial Door Operators / Fire Shutter Operators / Fire Shutter Operator

Grifco's unique portfolio of Fire Shutter Operators are designed and tested to perform on spring-balanced fire-rated roller shutters. The innovative controlled-descent mechanism ensures a safe and reliable descent in the event of an emergency.

Key Features

- Mechanical controlled-descent mechanism with fusible link
- Powerful 1.5Hp motor with purpose designed gearbox for durable, reliable operation
- Automatic chain-engage mechanism for safe and easy manual operation in the absence of power
- Choice of controls from Reversing Starters to the eDrive +2.0 Logic System for Mechanical Operators (GLMe2 portfolio)
- Full range of peripherals and accessories available

What's in the Box?

Fire Shutter Operator with Flag Mounting Bracket Only. All wall controls available separately

Information for Roller Shutters

All operators have a recommended maximum Roller Shutter area listed in the specification table. All recommended sizes are based on a "Standard Roller Shutter" (refer below):

- The Shutter is correctly spring balanced
- The Shutter has max 1.0mm x min 100mm slats, with a Diameter 150mm drum for shutters max 36m², or Diameter 200mm drum for shutters 36 - 50m²
- The Shutter has no wind-locks
- A sprocket ratio $\geq 4:1$ is used

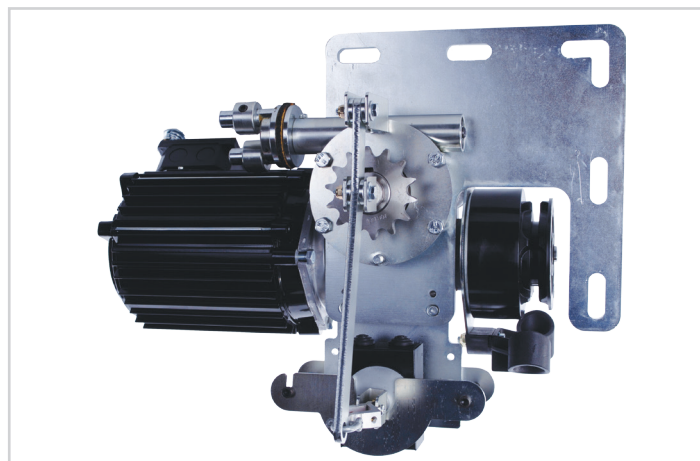

Product may differ slightly from image shown.

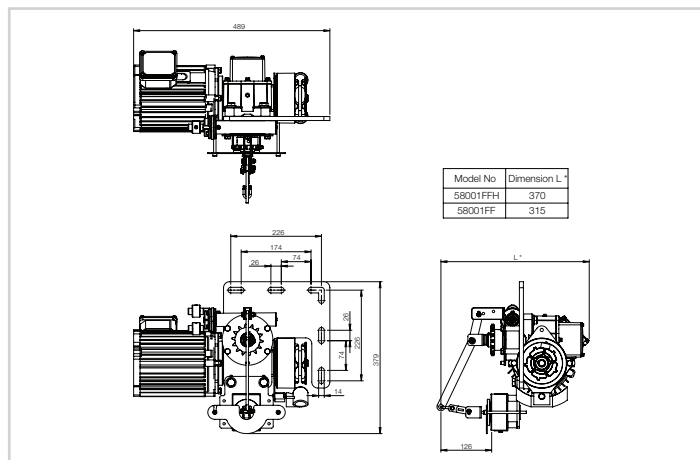

Product may differ slightly from image shown.

Model Details

Part No.	58017FF (L/R)
Description	FSO L/C 1.5Hp 415V 3PH IP44 FL

(L/R) indicates which side of the door opening the motor is mounted to (when viewed from inside the building). For example a model with an "L" suffix is mounted to the top left of the door opening.

Optional Controller Upgrade

Part No.	GLMe2
Description	eDrive +2.0 Logic Upgrade with Key Switch

Controller upgrade separately available. Please refer to the relevant Specification Sheet for details.

Specifications

kW	1.10kW	Phase	3ph	No Neutral (N)	N/A
Amps	2.55A	Max SB Door Size	36m ²	Pre-Wired (P)	N/A
Hp	1.5Hp	IP Rating	IP44	IP55 (W)	N/A
Voltage	415V	Duty Cycle	LC	Clutch (C)	N/A

LC = Low cycle (10% run time / hour).

HC = High cycle (30% run time / hour).

When specifying an upgraded model, please use the appropriate abbreviation before the "L" or "R" handing. For example 58017FFWR.

Upgrades:

O = Optional

S = Supplied as standard

N/A = Not applicable

Chamberlain Australia Pty Ltd

Head Office - Unit 1, 75 Epping Rd North Ryde NSW 2113
Manufacturing - 15 Dell Rd, West Gosford NSW 2250

Chamberlain New Zealand Ltd

17A Arrenway Dr, Rosedale 0632 Auckland NZ

AU: 1800 GRIFCO | www.grifco.com.au
NZ: 0800 653 667 | www.grifco.co.nz

Chamberlain Branches

Sydney - Unit 1, 75 Epping Rd North Ryde NSW 2113
Melbourne - Unit 18, 85-91 Keilor Park Dr Tullamarine VIC 3043
Brisbane - Unit 19, 140 Wecker Rd Mansfield QLD 4122
Perth - 54 Milrose Dr Malaga WA 6090